

Varenummer: 0102112
 Beskrivelse: Seeger låsering J 128 DIN 472
 Fjederstål

Mål

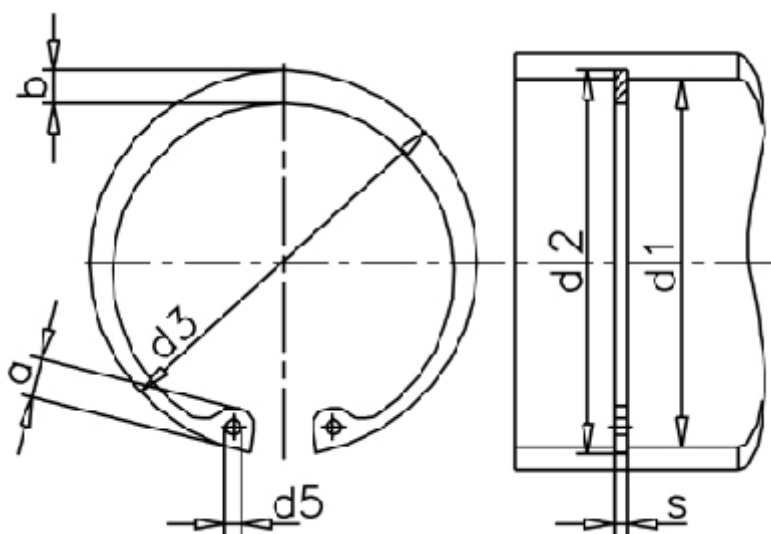

a max	= 11,0	FN kN	= 136.00	t	= 2.00
AN mm ²	= 816.0	FRg kN	= 69.0	Tang	= ZGJ-4
b	= 10.2	FR kN	= 378.0	tol	= -0.10
Betegnelse	= J 128	g	= 3.0	tol	= +1,50-0,63
d1	= 128	K kN-mm	= 802.0	tol	= +0,63
d2	= 132.0	m min	= 4.15	vægt kg/1000	= 81.00
d3	= 135.00	Nominel træk	= 6.0		
d5 min	= 4.0	s	= 4.00		